



aerospace
climate control
electromechanical
filtration
fluid & gas handling
hydraulics
pneumatics
process control
sealing & shielding



Robust air motors

Series P1V-M



ENGINEERING YOUR SUCCESS.

Features	Air motor	Hydraulic motor	Electric motor	Electric motor regulated	Electric motor regulated with feed back
Overload safe	***	***	*	**	***
Increased torque at higher loads	***	**	*	**	***
Easy to limit torque	***	***	*	*	***
Easy to vary speed	***	***	*	***	***
Easy to limit power	***	***	*	**	***
Reliability	***	***	***	***	***
Robustness	***	***	*	*	*
Installation cost	***	*	**	**	**
Ease of service	***	**	*	*	*
Safety in damp environments	***	***	*	*	*
Safety in explosive atmospheres	***	***	*	*	*
Safety risk with electrical installations	***	***	*	*	*
Risk of oil leak	***	*	***	***	***
Hydraulic system required	***	*	***	***	***
Weight	**	***	*	**	*
Power density	**	***	*	*	*
High torque for size	**	***	*	*	*
Noise level during operation	*	***	**	**	**
Total energy consumption	*	**	***	***	***
Service interval	*	**	***	***	***
Compressor capacity required	*	***	***	***	***
Purchase price	*	*	***	***	**
Accuracy, speed	*	**	*	**	***
Regulating dynamic	*	*	*	*	***
Communication	*	*	*	***	***

* = good, **=average, ***=excellent



Important!

Before carrying out service activities, make sure the air motor is vented. Before disassembling the motor, disconnect the primary air hose to ensure that the air supply is interrupted.



NOTE!

All technical data in the catalogue are typical values. The air quality is a major factor in the service life of the motor, see ISO 8573-1.



WARNING

FAILURE OR IMPROPER SELECTION OR IMPROPER USE OF THE PRODUCTS AND/OR SYSTEMS DESCRIBED HEREIN OR RELATED ITEMS CAN CAUSE DEATH, PERSONAL INJURY AND PROPERTY DAMAGE.

This document and other information from Parker Hannifin Corporation, its subsidiaries and authorized distributors provide product and/or system options for further investigation by users having technical expertise. It is important that you analyze all aspects of your application and review the information concerning the product or system in the current product catalog. Due to the variety of operating conditions and applications for these products or systems, the user, through its own analysis and testing, is solely responsible for making the final selection of the products and systems and assuring that all performance, safety and warning requirements of the application are met. The products described herein, including without limitation, product features, specifications, designs, availability and pricing, are subject to change by Parker Hannifin Corporation and its subsidiaries at any time without notice.

SALE CONDITIONS

The items described in this document are available for sale by Parker Hannifin Corporation, its subsidiaries or its authorized distributors. Any sale contract entered into by Parker will be governed by the provisions stated in Parker's standard terms and conditions of sale (copy available upon request).

Contents	Page
Robust Air Motors, Series P1V-M	4
Principles of air motor function.....	6
Torque, power and air consumption graphs	6
Correction diagram	7
Direction of motor rotation	7
Speed regulation	7
Air supply	8
Choice of components for air supply	8
Silencing.....	9
Sound levels	9
CE marking.....	9
Compressed air quality	10
Service interval.....	10
Choice of air motor	11
Technical data	12
Order key.....	12
Material specification	12
Permitted shaft loadings	13
Service kits for P1V-M motors	13
Data for P1V-M020A, 200 watt motor with flange.....	14
Data for P1V-M040A, 400 watt motor with flange.....	16
Data for P1V-M060A, 600 watt motor with flange.....	18
Dimensions, motors.....	20
Dimensions, foot brackets.....	21
Theoretical calculations.....	22-24
P1V-M Service – Easier - Faster - Cheaper	25
Torque, power and air consumption graphs	26

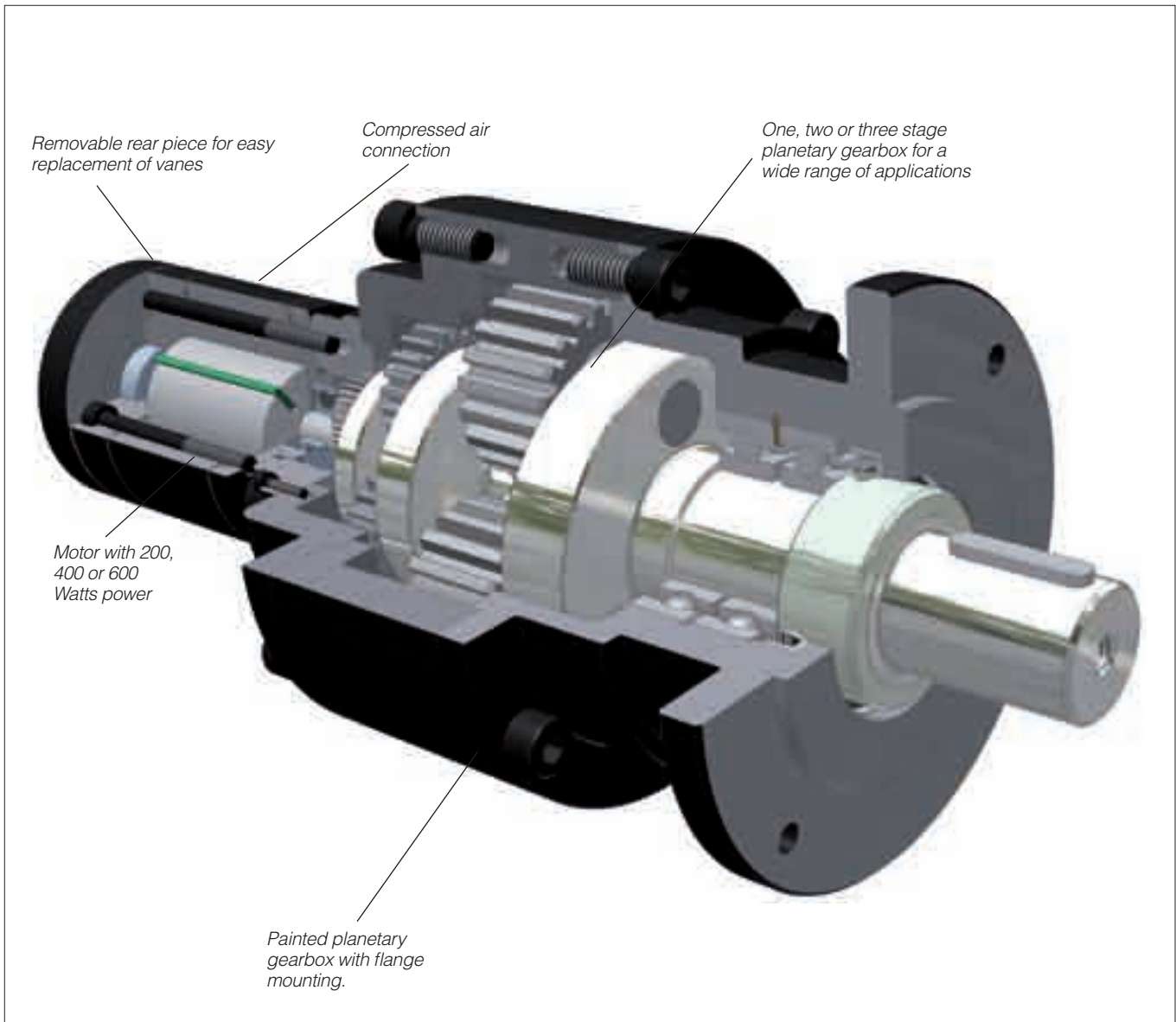

Robust Air Motors, Series P1V-M

P1V-M is a series of air motors, with planetary gearbox and motor made of black varnished steel. Its robustness makes it suitable for all normal air motor applications.

The range contains three different sizes with power ratings of 200, 400 or 600 Watts, shaft speeds ranging from 29 rpm to 10000 rpm, and torques up to 401 Nm at maximum power (more than 800 Nm torque if the motor is braked to stationary).

The standard range includes a total of 27 versions, covering all possible requirements for these power ratings.

The motor and gearbox are built to be extremely strong, making the motors suitable for applications requiring considerable robustness. The gearbox is of the planetary type, permanently lubricated with grease. The flange mounting is cast as an integral part of the case, and give, together with the foot

bracket, plenty of opportunity for simple and robust installation. To extract high torques at low speeds, the gearboxes have been made strong enough to withstand motor braking to stationary without being damaged.

A new design principle has made service activities quicker and easier than for any comparable motor. Servicing involves loosening the screws holding the rear piece to the motor, removing the worn vanes from the back and inserting the new vanes.

Unlike traditional air motors, there is no need to fully open the P1V-M for servicing, making the process much easier.

P1V-M Service – Easier - Faster - Cheaper
see page 25

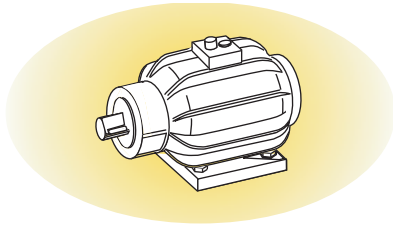

Air motors have much smaller installation dimensions than corresponding electric motors.

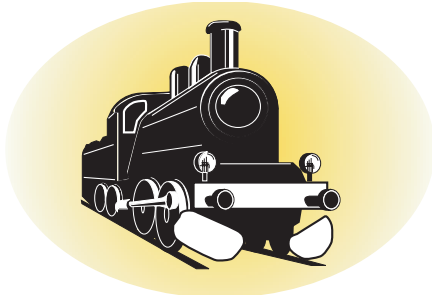

Air motors can be loaded until they stall, without damage. They are designed to be able to withstand the toughest heat, vibration, impact etc.

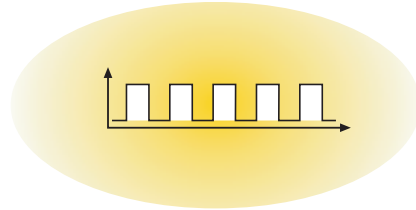

Air motors can be stopped and started continually without damage.

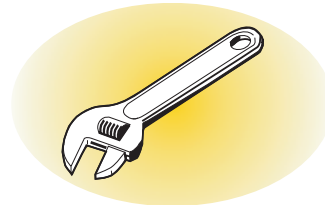

The simple design principle of air motors makes them very easy to service.



The weight of an air motor is several times less than corresponding electric motors.

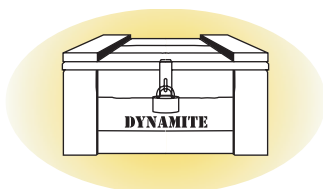

Air motors can be used in the harshest environments.

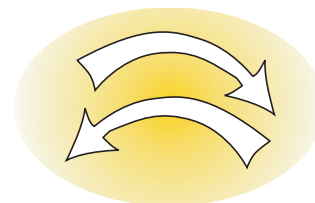

The motors are reversible as standard.

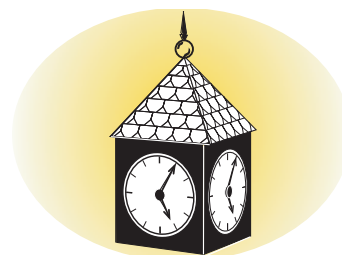

The reliability of air motors is very high, thanks to the design and the low number of moving parts.

Principles of air motor function

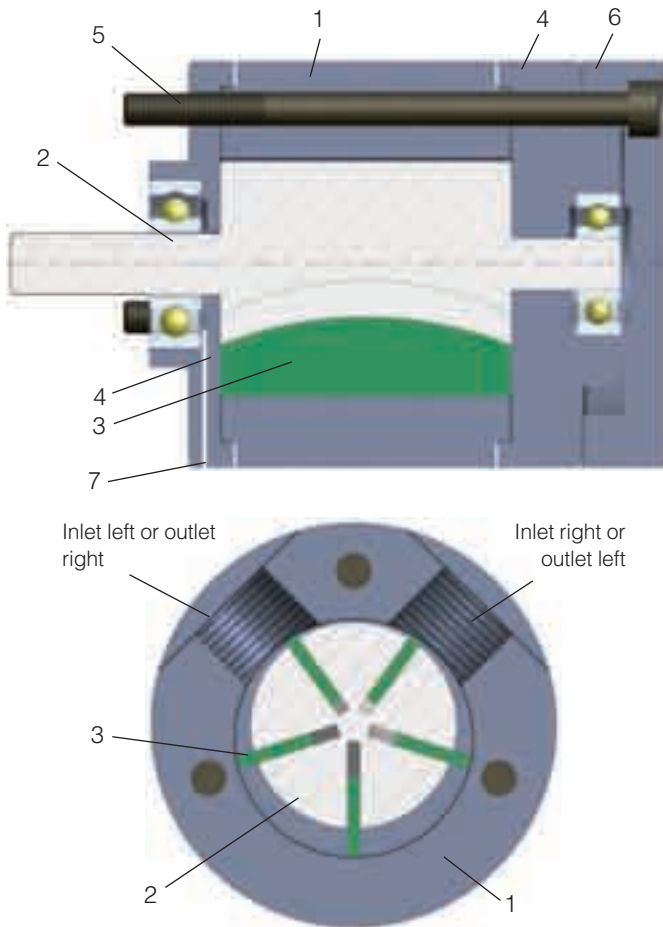

- 1 Rotor cylinder
- 2 Rotor
- 3 Vanes
- 4 End piece with bearing
- 5 Mounting screw for motor
- 6 Removable rear piece
- 7 Pressure unloading

There are a number of designs of air motor. Parker Pneumatic has chosen to use the vane rotor design, because of its simple design and reliable operation. The small external dimensions of vane motors make them suitable for all applications.

The principle of the vane motor is that a rotor with a number of vanes is enclosed in a rotor cylinder. The motor is supplied with compressed air through one connection and air escapes from the other connection. The air pressure always bears at right angles against a surface. This means that the torque of the motor is a result of the vane surfaces and the air pressure.

Torque, power and air consumption graphs

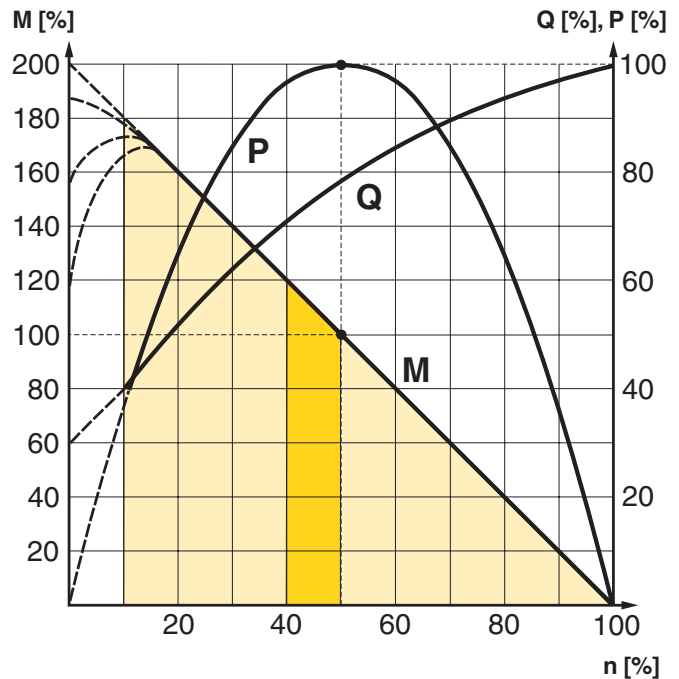

The curve is for 6 bar
P = power **Q = air consumption**
M = torque **n = speed**

- Possible working range of motor.
- Optimum working range of motor.
 Higher speeds = more vane wear
 Lower speeds with high torque = more gearbox wear

The performance characteristics of each motor are shown in a family of curves as above, from which torque, power and air consumption can be read off as a function of speed. Power is zero when the motor is stationary and also when running at free speed (100%) with no load. Maximum power (100%) is normally developed when the motor is braked to approximately half the free speed (50%).

Torque at free speed is zero, but increases as soon as a load is applied, rising linearly until the motor stalls. As the motor can stop with the vanes in various positions, it is not possible to specify an exact starting torque. However, a minimum starting torque is shown in all tables.

Air consumption is greatest at free speed, and decreases with decreasing speed, as shown in the above diagram.

Please refer to the curve on page 26 for these pressures:
3, 4, 5, 6 and 7 bar

Correction diagram

Correction factor

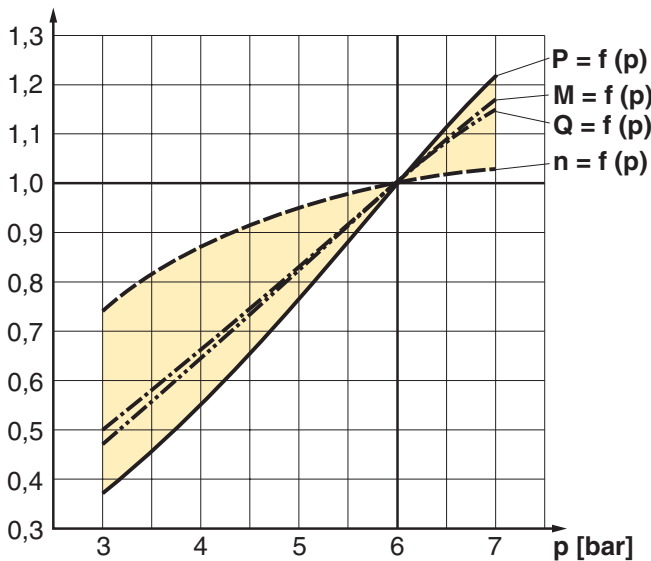

P = power	Q = air consumption
M = torque	n = speed

All catalogue data and curves are specified at a supply pressure of 6 bar to the motor. This diagram shows the effect of pressure on speed, specified torque, power and air consumption.

Start off on the curve at the pressure used and then look up to the lines for power, torque, air consumption or speed. Read off the correction factor on the Y axis for each curve and multiply this by the specified catalogue data in the table, or data read from the torque and power graphs.

Example: at 4 bar supply pressure, the power is only 0.55 x power at 6 bar supply pressure.

This example shows how strongly power falls if supply pressure is reduced. You must therefore ensure that the motor is supplied through pipes of sufficient diameter to avoid pressure drop.

Direction of motor rotation

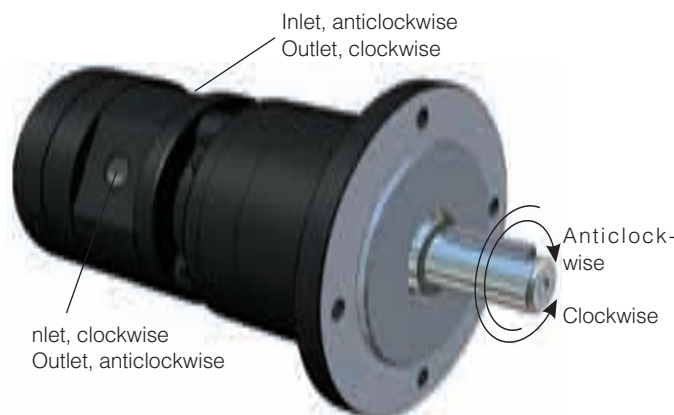

The direction of rotation of reversible motors is controlled by supplying inlet L or inlet R with compressed air. The motor can be stopped and started continually without damage occurring.

Speed regulation

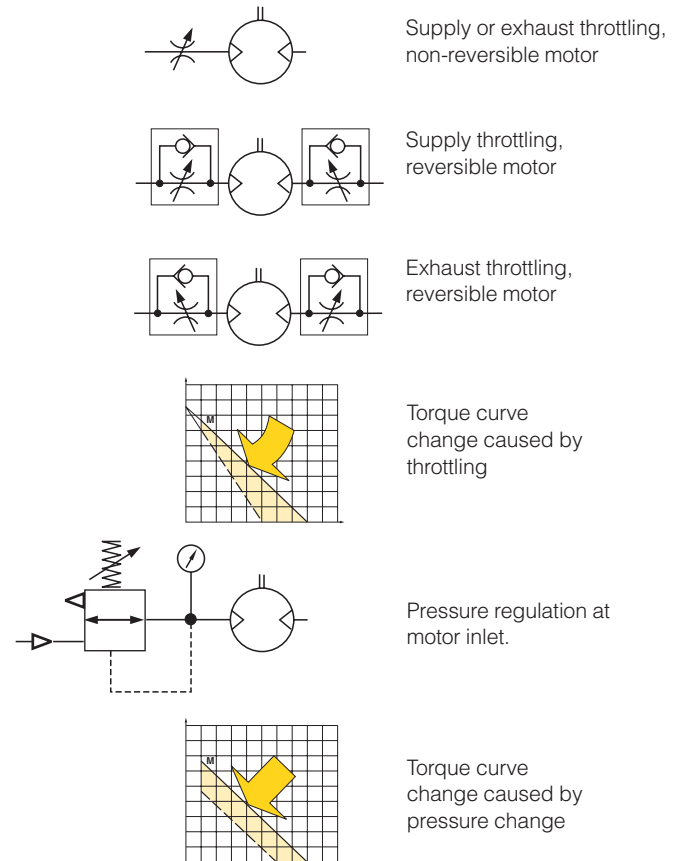

Throttling

The most common way to reduce the speed of a motor is to install a flow control valve in the air inlet. When the motor is used in applications where it must reverse and it is necessary to restrict the speed in both directions, flow control valves with by-pass should be used in both directions.

Inlet throttling

If the inlet air is restricted, the air supply is restricted and the free speed of the motor falls, but there is full pressure on the vanes at low speeds. This means that we get full torque from the motor at low speeds despite the low air flow.

Since the torque curve becomes “steeper”, this also means that we get a lower torque at any given speed than would be developed at full air flow.

Pressure regulation

The speed and torque can also be regulated by installing a pressure regulator in the inlet pipe. This means that the motor is constantly supplied with air at lower pressure, which means that when the motor is braked, it develops a lower torque on the output shaft.

In brief: *Inlet throttling* gives reduced speed in one direction but maintains torque when braked. *The torque curve becomes steeper.* *Pressure regulation* in the inlet cuts torque when the motor is braked, and also reduces speed. *The torque curve is moved parallel.*

The direction of rotation of reversible motors is obtained by supplying inlet L or inlet R with compressed air. The motor can be stopped and started continually without damage occurring.

Air supply

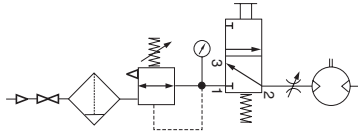

Shut-off, filtering, pressure regulation and control valve

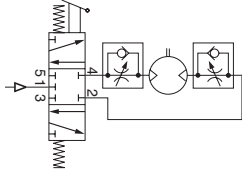

Reversible motor with 5/3 control valve

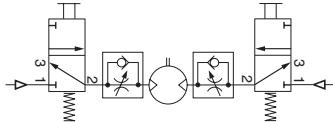

Reversible motor with two 3/2 control valves

The air supplying the motor must be filtered and regulated. Directional valves are needed to provide it with air, to get the motor to rotate when we want it to. These valves can be equipped with several means of actuation, such as electric, manual or pneumatic control. When the motor is used in a nonreversible application, it is sufficient to use a 2/2 or 3/2 valve for supply. Either one 5/3 or two 3/2 valves are needed for a reversible motor, to ensure that the motor receives compressed air and the residual air outlet is vented. A flow control valve can be installed in the supply pipe to regulate the motor speed if the motor is not used as a reversible motor. One flow control valve with by-pass is needed to regulate each direction of rotation if the motor is used as a reversible motor. The built-in check valve will then allow air from the residual air outlet to escape through the outlet port in the control valve.

The compressed air supply must have sufficiently large pipes and valves to give the motor maximum power. The motor needs 6 bar at the supply port all the time. A reduction of pressure to 5 bar reduces the power developed to 77%, and to 55% at 4 bar.

Choice of components for air supply

Since the supply pressure at the air motor inlet port is of considerable importance for obtaining the power, speed and torque quoted in the catalogue, the recommendations below should be observed.

The following data must be complied with:

Supply pressure to air treatment unit:	Min 7.5 bar
Manometer pressure:	6.7 bar
Pipe length between air treatment unit and valve:	max. 1 m
Pipe length between valve and air motor:	max. 2 m
The pressure drop through air treatment unit - pipe - valve - pipe means that 6 bar pressure is obtained at the motor supply port.	

Please refer to the correction diagram on page 7, which shows the effect of lower supply pressure in terms of power, speed and torque.

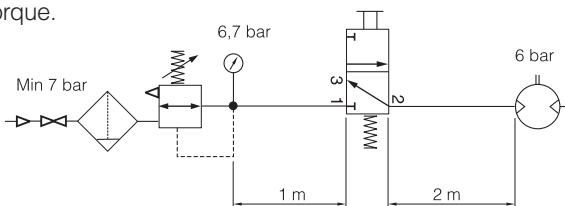

The table can be used as follows:

If you are using only one motor with each air treatment unit and valve, simply follow the table. If you are using more than one motor with the same air treatment unit: read the table values for selecting the air treatment unit and add them together, and select a suitable air treatment unit from the table showing air flows per treatment unit. Then read the values for selecting the valve from the bottom of the table, and select a suitable valve from the table showing air flows per valve family.

The air treatment units have the following flows in NI/Min at 7.5 bar supply pressure and 0.8 bar pressure drop

FRL series	Air flow in NI/Min
P3H, Moduflex FRL, 40 Series, G1/4	550
P3K, Moduflex FRL, 60 Series, G1/2	1310
P3M, Moduflex FRL, 80 Series, G1	2770
Standard series FRL, G11/2	9200
Stainless series FRL PF, G1/4	530
Stainless series FRL PF, G1/2	1480

Valve series with respective flows in NI/minute

Valve series	Qn in NI/Min
Valvetronic Solstar	33
Interface PS1	100
Adex A05	173
Moduflex size 1, (2 x 3/2)	220
Valvetronic PVL-B 5/3 closed centre, 6 mm push in	290
Moduflex size 1, (4/2)	320
B43 Manual and mechanical	340
Valvetronic PVL-B 2 x 2/3, 6 mm push in	350
Valvetronic PVL-B 5/3 closed centre, G1/8	370
Compact Isomax DX02	385
Valvetronic PVL-B 2 x 3/2 G1/8	440
Valvetronic PVL-B 5/2, 6 mm push in	450
Valvetronic PVL-B 5/3 vented centre, 6 mm push in	450
Moduflex size 2, (2 x 3/2)	450
Flowstar P2V-A	520
Valvetronic PVL-B 5/3 vented centre, G1/8	540
Valvetronic PVL-B 5/2, G1/8	540
Valvetronic PVL-C 2 x 3/2, 8 mm push in	540
Adex A12	560
Valvetronic PVL-C 2 x 3/2 G1/8	570
Compact Isomax DX01	585
VIKING Xtreme P2LAX	660
Valvetronic PVL-C 5/3 closed centre, 8 mm push in	700
Valvetronic PVL-C 5/3 vented centre, G1/4	700
B3-Series	780
Valvetronic PVL-C 5/3 closed centre, G1/4	780
Moduflex size 2, (4/2)	800
Valvetronic PVL-C 5/2, 8 mm push in	840
Valvetronic PVL-C 5/3 vented centre, 8 mm push in	840
Valvetronic PVL-C 5/2, G1/4	840
Flowstar P2V-B	1090
ISOMAX DX1	1150
B53 Manual and mechanical	1160
B4-Series	1170
VIKING Xtreme P2LBX	1290
B5-Series, G1/4	1440
Airline Isolator Valve VE22/23	1470
ISOMAX DX2	2330
VIKING Xtreme P2LCX, G3/8	2460
VIKING Xtreme P2LDX, G1/2	2660
ISOMAX DX3	4050
Airline Isolator Valve VE42/43	5520
Airline Isolator Valve VE82/83	13680

Choice of components for air supply

Motor	P1V-M020	P1V-M040	P1V-M060				
Air flow required, NI/s	6,5	9,5	15,0				
Air flow required, NI/min	390	570	900				
Min. internal diameter of pipe, mm	10	12	12				
Choice of air treatment unit: recommended min. air flow in litres/minute at 7.5 bar air supply and 0.8 bar pressure drop							
	430						
		630					
			990				
Choice of valve: recommended min. air flow in Qn in litres/minute (Qn is the flow through the valve at 6 bar supply pressure and 1 bar pressure drop over the valve).							
	470						
		690					
			1080				

Silencing

Exhaust silencer

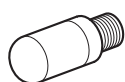

Central silencer

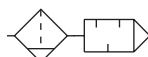

The noise from an air motor consists of both mechanical noise and a pulsating noise from the air flowing out of the outlet. The installation of the motor has a considerable effect on mechanical noise. It should be installed so that no mechanical resonance effects can occur. The outlet air creates a noise level which can amount to 115 dB(A) if the air is allowed to exhaust freely into the atmosphere. Various types of exhaust silencers are used to reduce this level. The most common type screws directly onto the exhaust port of the motor, and a wide range of versions is available made of sintered brass or sintered plastic. Since the motor function causes the exhaust air to pulsate, it is a good idea to allow the air to exhaust into some kind of chamber first, which reduces the pulsations before they reach the silencer. The best silencing method is to connect a soft hose to a central silencer with the largest possible area, to reduce the speed of the out-flowing air as far as possible.

NOTE! Remember that if a silencer is too small or is blocked, back pressure is generated on the outlet side of the motor, which in turn reduces the motor power.

Sound levels

Sound levels are measured at free speed with the measuring instrument positioned 1 m away from the air motor, see the table below

Air motor	Free exhaust	With exhaust silencer	Exhaust air removed with pipes to another room
	dB (A)	dB (A)	dB (A)
P1V-M020	107	97	74
P1V-M040	107	98	80
P1V-M060	107	99	82

CE marking

The air motors are supplied as "Components for installation" – the installer is responsible for ensuring that the motors are installed safely in the overall system. Parker Pneumatic guarantees that its products are safe, and as a supplier of pneumatic equipment we ensure that the equipment is designed and manufactured in accordance with the applicable EU directive.

Most of our products are classed as components as defined by various directives, and although we guarantee that the components satisfy the fundamental safety requirements of the directives to the extent that they are our responsibility, they do not usually carry the CE mark. Nevertheless, most P1V-S motors carry the CE mark because they are ATEX certified (for use in explosive atmospheres).

The following are the currently applicable directives:

- Machinery Directive (essential health and safety requirements relating to the design and structure of machines and safety components)
- EMC Directive
- Simple Pressure Vessels Directive
- Low Voltage Directive
- ATEX Directive (ATEX = ATmosphere EXplosive)

Compressed air quality

The P1V-M motor is equipped with vanes for intermittent lubrication free operation as standard, which is the most common application of air motors.

Working pressure	Max 7 bar
Working temperature	-30 °C to +100 °C
Medium	40 µm filtered, oil mist or dry un lubricated compressed air

Dry un lubricated compressed air

If un lubricated compressed air is used, the compressed air should comply with the purity standards below in order to guarantee the longest possible overall service life. If the un lubricated compressed air has a high water content, condensation forms inside the motor, causing corrosion in all internal components. A ballbearing can be destroyed in a remarkably short time if it comes into contact with a single water droplet.

For indoor use, we recommend ISO8573-1 purity class 3.4.1. To achieve this, compressors must be fitted with aftercoolers, oil filters, refrigerant air dryers and air filters.

For indoor/outdoor use, we recommend ISO8573-1 purity class 1.2.1. To achieve this, compressors must be fitted with aftercoolers, oil filters, adsorption dryers and dust filters.

Oil mist

If oil mist is used (approx. 1 drop of oil per m³ of compressed air), the oil not only acts as a lubricant but also protects against corrosion. This means that compressed air with a certain water content may be used without causing corrosion problems inside the motor.

ISO8573-1 purity class 3.-5 may be used without difficulty.

ISO 8573-1 purity classes

Quality class	Contaminants		Water max. pressure dew point (°C)	Oil max. concentration (mg/m ³)
	particle size (µm)	max. concentration (mg/m ³)		
1	0,1	0,1	-70	0,01
2	1	1	-40	0,1
3	5	5	-20	1,0
4	15	8	+3	5,0
5	40	10	+7	25
6	-	-	+10	-

For example: compressed air to purity class 3.4.3

This means a 5 µm filter (standard filter), dew point +3 °C (refrigerant cooled) and an oil concentration of 1,0 mg oil/m³ (as supplied by a standard compressor with a standard filter).

Service interval

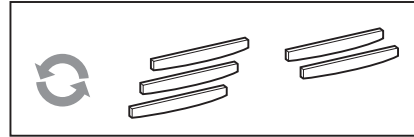

The first service is due after approximately 500 hours of operation. After the first service, the service interval is determined by the degree of vane wear*. The table below shows new dimensions and the minimum dimensions of worn vanes.

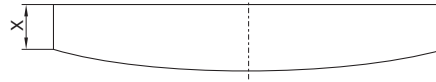

Air motor	Dimensions on new vanes X [mm]	Minimum dimensions on vane X [mm]
P1V-M020	8,5	6,5
P1V-M040	7,0	5,0
P1V-M060	8,0	6,0

The following normal service intervals should be applied to in order to guarantee problem-free operation in air motors working continuously at load speeds*.

Intermittent lubrication-free operation of motors with standard vanes

Duty cycle :	70%
Max. duration of intermittent use :	15 minutes
Filtration 40 µm :	750 hours of operation*
Filtration 5 µm :	1 000 hours of operation*

Continuous operation of motors with standard vanes, with lubrication

Duty cycle :	Continuous
Quantity of oil :	1 drop per m ³ of air
Filtration 40 µm :	1 000 hours of operation*
Filtration 5 µm :	2 000 hours of operation*

NOTE! The grease in the planetary gearbox must be checked once in a year and be changed if necessary. (Molycote BR2+)



* The specified hours of operation apply when the motor is running at the speed corresponding to maximum power (load speed). This is approximately half free speed. If the motor operates at higher speeds, the service interval is shorter. If the motor operates at lower speeds, the service interval is longer.

Choice of air motor

Torque at maximum power [Nm]

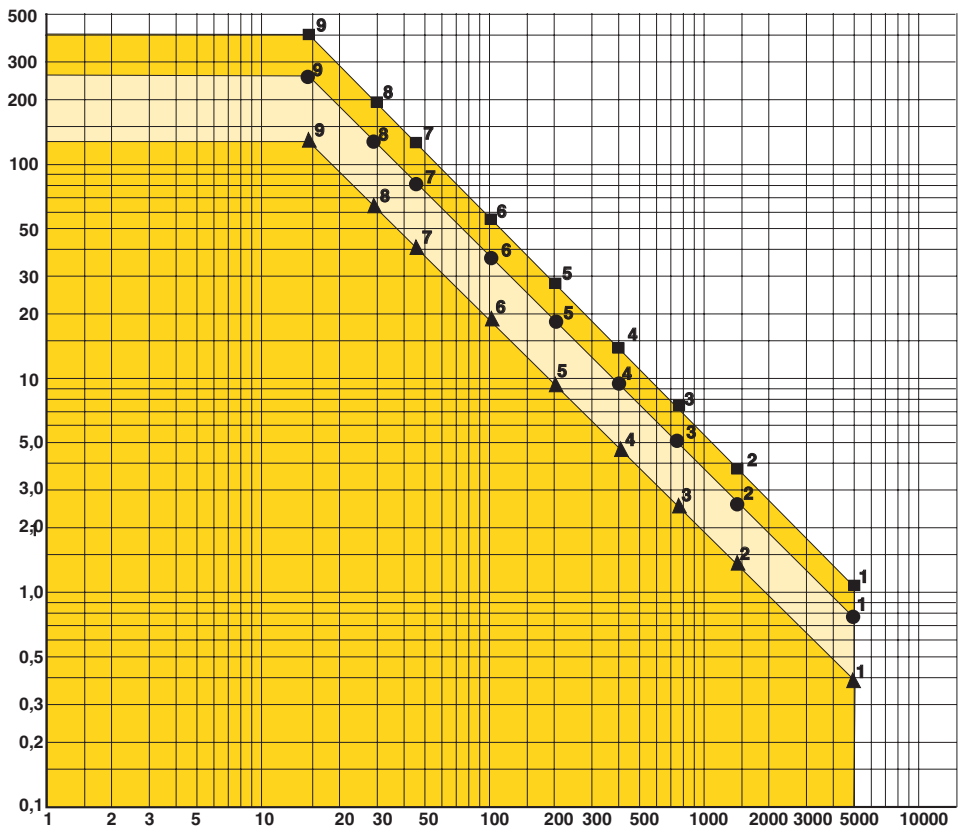

Speed at maximum power [rpm]

The motor to be used should be selected by starting with the torque needed at a specific shaft speed. In other words, to choose the right motor, you have to know the required speed and torque. Since maximum power is reached at half the motor's free speed, the motor should be chosen so that the operating point is as close as possible to the maximum power of the motor.

The design principle of the motor means that higher torque is generated when it is braked, which tends to increase the speed, etc. This means that the motor has a kind of speed self-regulation function built in.

Use the above graph to choose the correct motor size. The graph contains the points for the maximum torque of each motor at maximum output. Add your operating point to the graph, then select a marked point above and to the right of your point.

Then use the correct working diagram of the chosen motor to get more detailed technical data. Always select a motor whose requisite technical data are in the shaded area. Also use the correction diagram to find out what operation with different supply pressures would mean for the motor.

Tip: Select a motor which is slightly too fast and powerful, then regulate its speed and torque with a pressure regulator and/or throttle to achieve the optimum working point.

Air motors in diagram above

- ▲ 1 P1V-M020A0A00
- ▲ 2 P1V-M020A0290
- ▲ 3 P1V-M020A0150
- ▲ 4 P1V-M020A0081
- ▲ 5 P1V-M020A0041
- ▲ 6 P1V-M020A0021
- ▲ 7 P1V-M020A0009
- ▲ 8 P1V-M020A0006
- ▲ 9 P1V-M020A0003

Graph for each motor, please refer to page 15

- 1 P1V-M040A0A00
- 2 P1V-M040A0290
- 3 P1V-M040A0150
- 4 P1V-M040A0081
- 5 P1V-M040A0041
- 6 P1V-M040A0021
- 7 P1V-M040A0009
- 8 P1V-M040A0006
- 9 P1V-M040A0003

Graph for each motor, please refer to page 17

- 1 P1V-M060A0A00
- 2 P1V-M060A0290
- 3 P1V-M060A0150
- 4 P1V-M060A0081
- 5 P1V-M060A0041
- 6 P1V-M060A0021
- 7 P1V-M060A0009
- 8 P1V-M060A0006
- 9 P1V-M060A0003

Graph for each motor, please refer to page 19

Order key

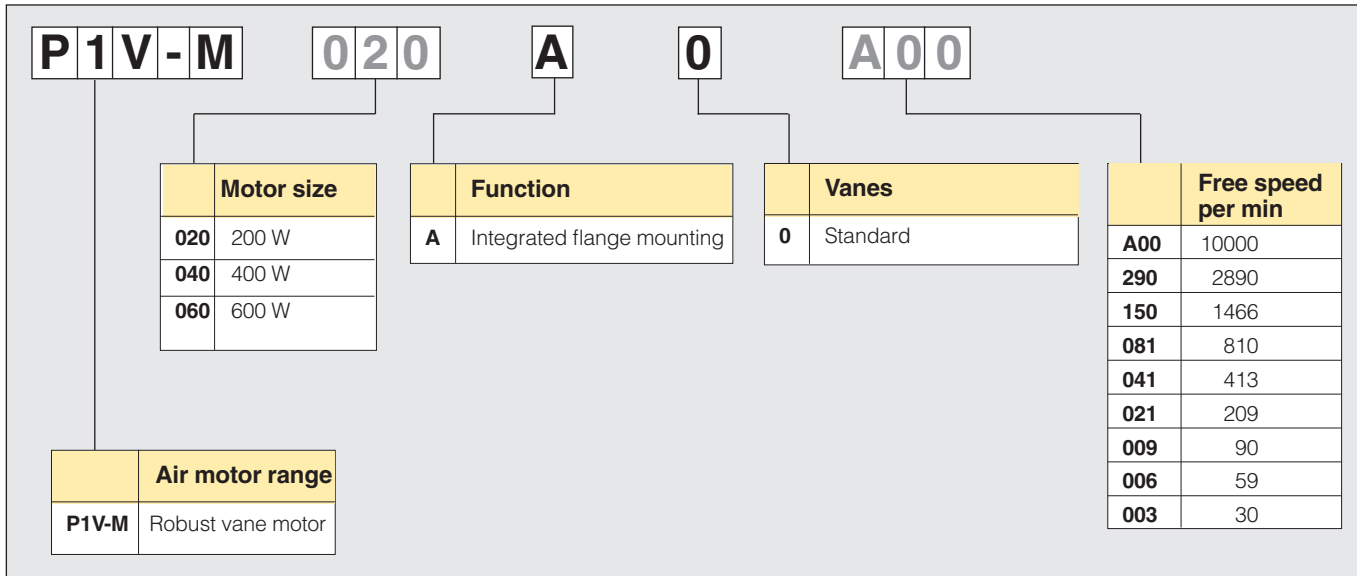

Possible combinations

Please refer to pages 14 to 18

Technical data

Working pressure	Max 7 bar
Working temperature	-30 °C to +100 °C
Medium	Filtered dry air and oil mist, purity class ISO 8573-1 class 3.-5 for indoor use and with a dew point lower than ambient temperature for outdoor use.

Material specification

Planetary gearbox	Painted cast iron/Aluminium
Motor housing	Painted steel
Shaft	Hardened steel
Key	Hardened steel
External seal	Fluor rubber, FPM
Internal steel parts	High grade steel
Gearbox lubrication	Grease

Table and diagram data

All values are typical values, with a tolerance of ±10%

P1V-M motors are of the vane type for intermittent lubrication-free operation. They can operate 70% of the time for up to 15 minutes without lubrication. With lubrication, these motors can operate 100% of the time.

Permitted shaft loadings

Basic motors

Max. permitted load on output shaft for basic motors (based on 10,000 rpm at input shaft with 90 % probable service life for ball bearings).

Shaft with key slot

Order code	Fax [N]	Frad [N]	a [mm]	Bearing service life [hours]
Motor P1V-M0●0●●●A00				
Motor P1V-M0●0●●●290				
Motor P1V-M0●0●●●150				
High speed	93	140	15	20000
	93	120	15	30000
	93	110	15	40000
Low speed	93	160	15	20000
	93	150	15	30000
	93	140	15	40000
Motor P1V-M0●0●●●081				
Motor P1V-M0●0●●●041				
Motor P1V-M0●0●●●021				
High speed	150	200	15	20000
	150	175	15	30000
	150	170	15	40000
Low speed	260	345	15	20000
	260	290	15	30000
	260	275	15	40000
Motor P1V-M0●0●●●009				
Motor P1V-M0●0●●●006				
Motor P1V-M0●0●●●003				
High speed	450	625	15	20000
	450	550	15	30000
	450	500	15	40000
Low speed	850	1000	15	20000
	850	1100	15	30000
	850	1250	15	40000

F_{rad} = Radial loading (N)

F_{ax} = Axial loading (N)

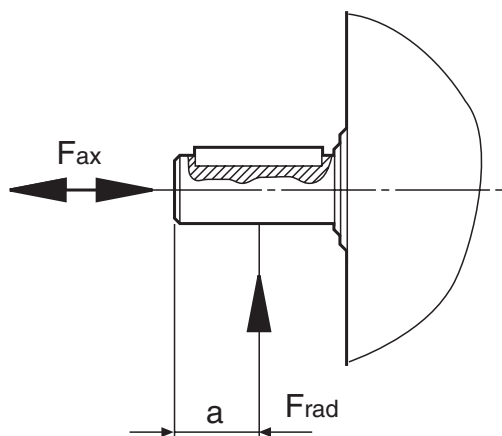
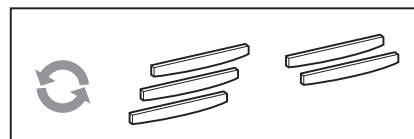

Fig 1: Load on output shaft for basic motor with shaft with key slot.

Service kits for P1V-M motors

The following kits are available for the basic motors, consisting of vanes and O-ring:



Service kit

For motor	Order code
P1V-M020	P1V-6/831297A
P1V-M040	P1V-6/831298A
P1V-M060	P1V-6/831299A

Spare parts

New basic motors	Order code
P1V-M020	P1V-M020M
P1V-M040	P1V-M040M
P1V-M060	P1V-M060M

New gearboxes with flange

	Order code
A0A00	P1V-MGA00
A0290	P1V-MG290
A0150	P1V-MG150
A0081	P1V-MG081
A0041	P1V-MG041
A0021	P1V-MG021
A0009	P1V-MG009
A0006	P1V-MG006
A0003	P1V-MG003

NOTE! All technical data is based on a working pressure of 6 bar.



P1V-M020A0A00
P1V-M020A0290
P1V-M020A0150



P1V-M020A0081
P1V-M020A0041
P1V-M020A0021



P1V-M020A0009
P1V-M020A0006
P1V-M020A0003

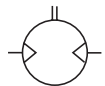

Data for P1V-M020A, 200 watt motor with flange

Max power	Free speed	Speed at max power	Torque at max power	Min start torque	Air consumption at max power	Conn.	Min pipe ID	Weight	Order code
kW	r/Min	r/Min	Nm	Nm	l/s		mm	Kg	
0,200	10 000	5 000	0,38	0,57	6,5	G1/8	10	1,94	P1V-M020A0A00
0,200	2 890	1 445	1,31	1,97	6,5	G1/8	10	1,94	P1V-M020A0290
0,200	1 466	733	2,59	3,89	6,5	G1/8	10	1,94	P1V-M020A0150
0,200	810	405	4,69	7,04	6,5	G1/8	10	2,94	P1V-M020A0081
0,200	413	206	9,20	13,81	6,5	G1/8	10	2,94	P1V-M020A0041
0,200	209	105	18,14	27,21	6,5	G1/8	10	2,94	P1V-M020A0021
0,200	90	45	42,34	63,50	6,5	G1/8	10	7,44	P1V-M020A0009
0,200	59	29	64,76	97,15	6,5	G1/8	10	7,44	P1V-M020A0006
0,200	30	15	126,99	190,48	6,5	G1/8	10	7,44	P1V-M020A0003

Dimensions, see page 20
Foot brackets, see page 21
Permitted shaft loadings, see page 13
Service kits, see page 13

P1V-M020A0A00

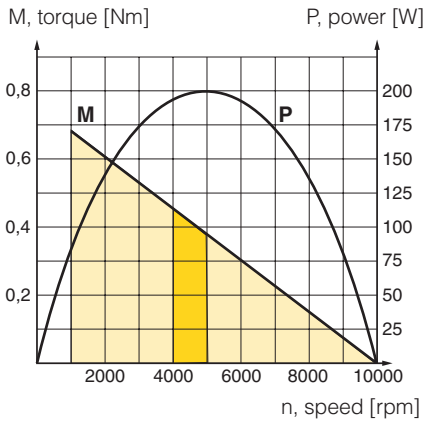

P1V-M020A0290

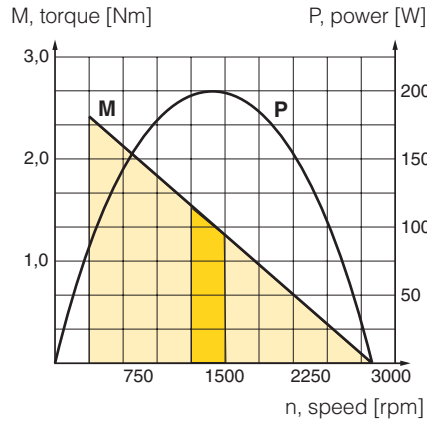

P1V-M020A0150

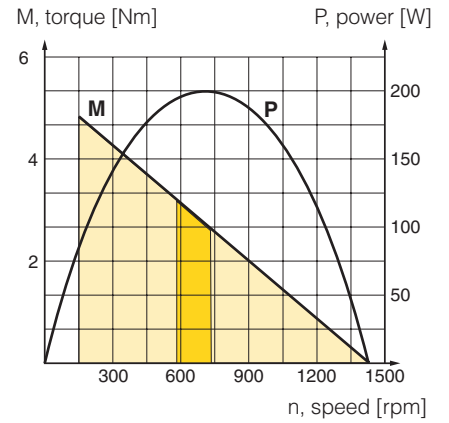

P1V-M020A0081

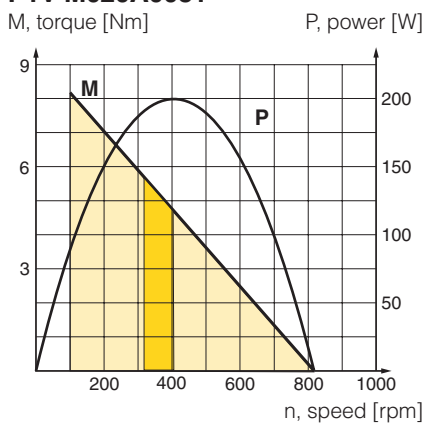

P1V-M020A0041

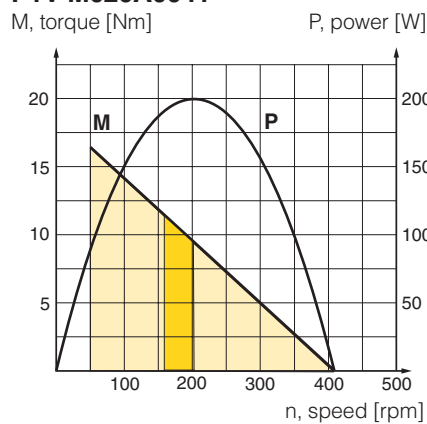

P1V-M020A0021

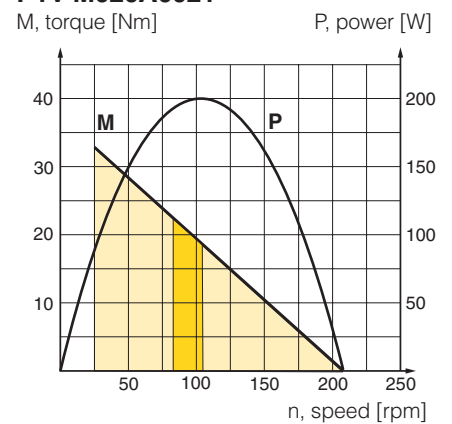

P1V-M020A0009

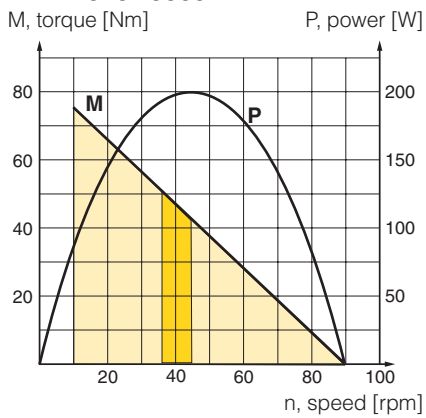

P1V-M020A0006

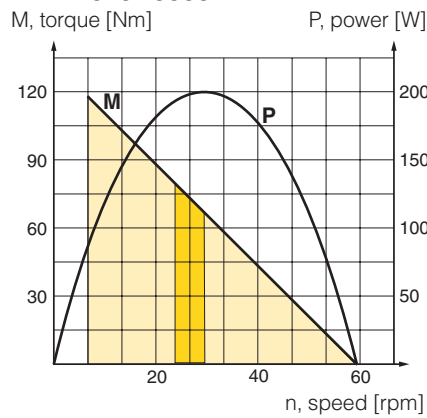

P1V-M020A0003

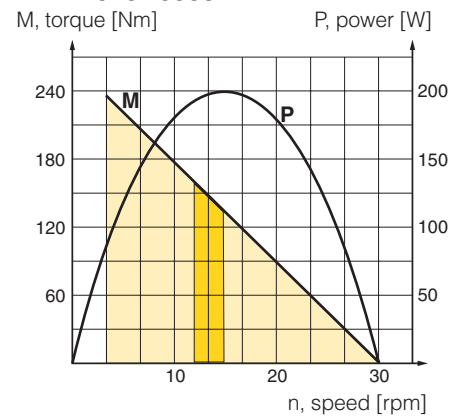

 Possible working range of motor.

 Optimum working range of motor.

Higher speeds = more vane wear
Lower speeds with high torque = more gearbox wear

NOTE! All technical data is based on a working pressure of 6 bar.



P1V-M040A0A00
P1V-M040A0290
P1V-M040A0150



P1V-M040A0081
P1V-M040A0041
P1V-M040A0021



P1V-M040A0009
P1V-M040A0006
P1V-M040A0003

Data for P1V-M040A, 400 watt motor with flange

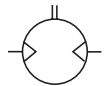

Max power	Free speed	Speed at max power	Torque at max power	Min start torque	Air consumption at max power	Conn.	Min pipe ID	Weight	Order code
kW	r/Min	r/Min	Nm	Nm	l/s		mm	Kg	
0,400	10 000	5 000	0,76	1,15	9,5	G3/8	12	2,32	P1V-M040A0A00
0,400	2 890	1 445	2,63	3,98	9,5	G3/8	12	2,32	P1V-M040A0290
0,400	1 466	733	5,18	7,84	9,5	G3/8	12	2,32	P1V-M040A0150
0,400	810	405	9,39	14,20	9,5	G3/8	12	4,32	P1V-M040A0081
0,400	413	206	18,41	27,85	9,5	G3/8	12	4,32	P1V-M040A0041
0,400	209	105	36,28	54,90	9,5	G3/8	12	4,32	P1V-M040A0021
0,400	90	45	84,67	128,12	9,5	G3/8	12	7,82	P1V-M040A0009
0,400	59	29	129,53	195,99	9,5	G3/8	12	7,82	P1V-M040A0006
0,400	30	15	253,98	384,31	9,5	G3/8	12	7,82	P1V-M040A0003

Dimensions, see page 20
Foot brackets, see page 21
Permitted shaft loadings, see page 13
Service kits, see page 13

P1V-M040A0A00

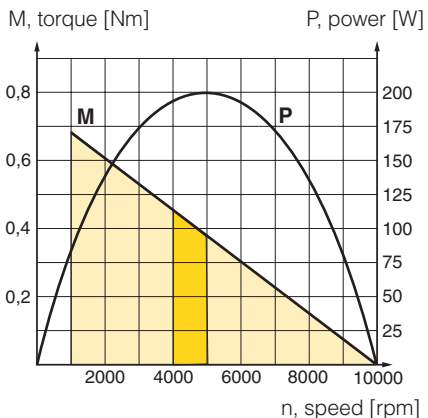

P1V-M040A0290

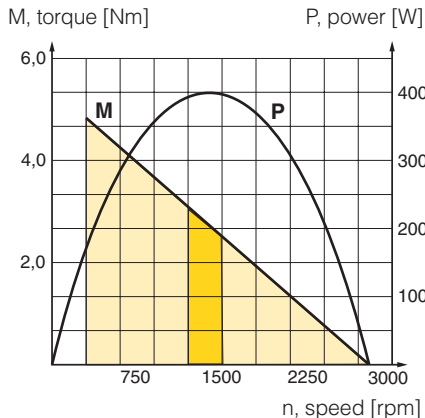

P1V-M040A0150

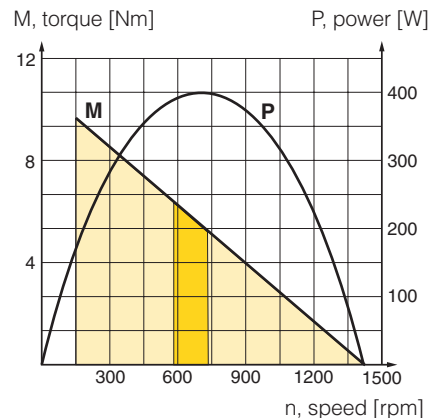

P1V-M040A0081

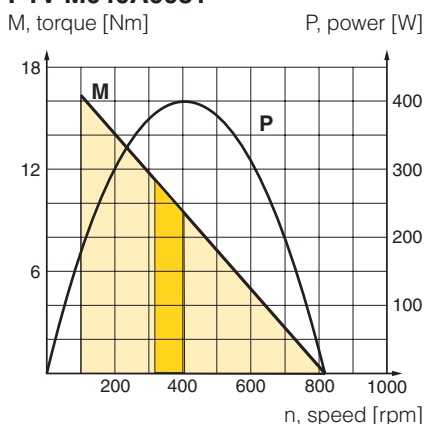

P1V-M040A0041

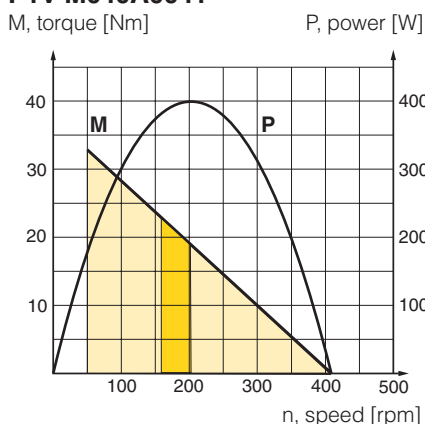

P1V-M040A0021

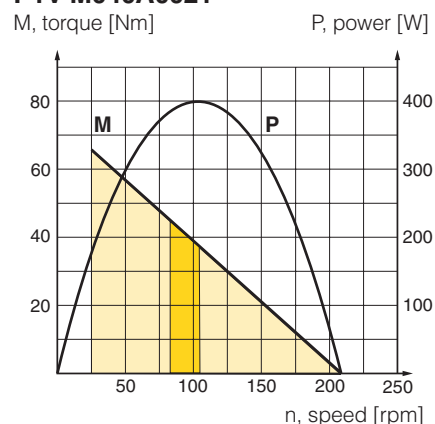

P1V-M040A0009

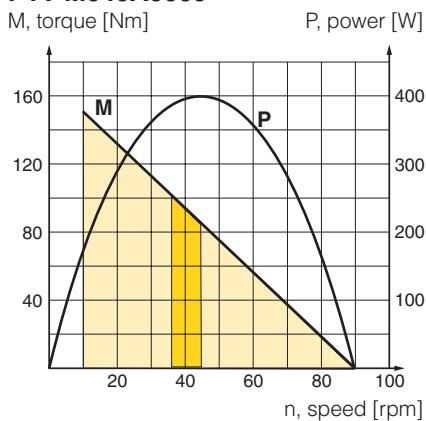

P1V-M040A0006

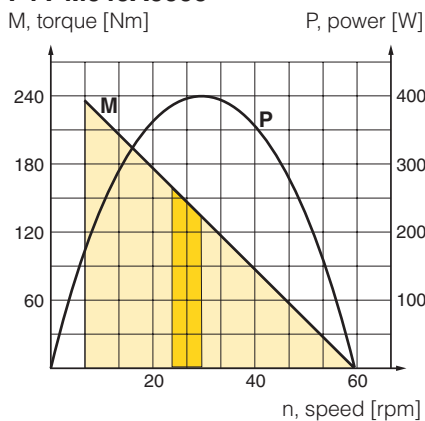

P1V-M040A0003

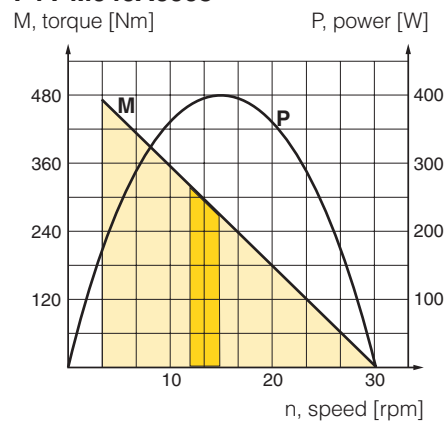

 Possible working range of motor.

 Optimum working range of motor.

Higher speeds = more vane wear
Lower speeds with high torque = more gearbox wear

NOTE! All technical data is based on a working pressure of 6 bar.

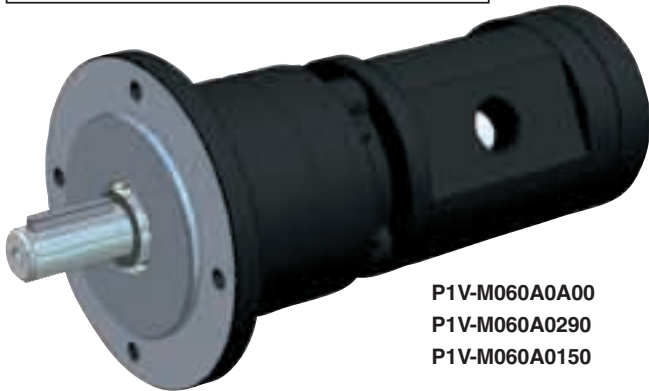

P1V-M060A0A00
P1V-M060A0290
P1V-M060A0150



P1V-M060A0081
P1V-M060A0041
P1V-M060A0021



P1V-M060A0009
P1V-M060A0006
P1V-M060A0003

Data for P1V-M060A, 600 watt motor with flange

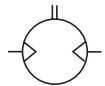

Max power	Free speed	Speed at max power	Torque at max power	Min start torque	Air consumption at max power	Conn.	Min pipe ID	Weight	Order code
kW	r/Min	r/Min	Nm	Nm	l/s		mm	Kg	
0,600	10 000	5 000	1,14	1,71	15,0	G3/8	12	5,59	P1V-M060A0A00
0,600	2 890	1 445	3,94	5,92	15,0	G3/8	12	5,59	P1V-M060A0290
0,600	1 466	733	7,77	11,66	15,0	G3/8	12	5,59	P1V-M060A0150
0,600	810	405	14,08	21,12	15,0	G3/8	12	6,59	P1V-M060A0081
0,600	413	206	27,61	41,42	15,0	G3/8	12	6,59	P1V-M060A0041
0,600	209	105	54,42	81,64	15,0	G3/8	12	6,59	P1V-M060A0021
0,600	90	45	127,01	190,51	15,0	G3/8	12	11,09	P1V-M060A0009
0,600	59	29	194,29	291,44	15,0	G3/8	12	11,09	P1V-M060A0006
0,600	30	15	380,97	571,45	15,0	G3/8	12	11,09	P1V-M060A0003

Dimensions, see page 20
Foot brackets, see page 21
Permitted shaft loadings, see page 13
Service kits, see page 13

P1V-M060A0A00

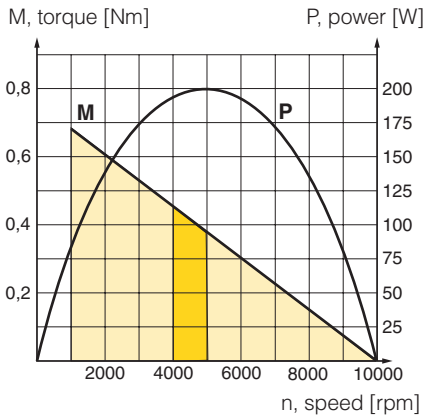

P1V-M060A0290

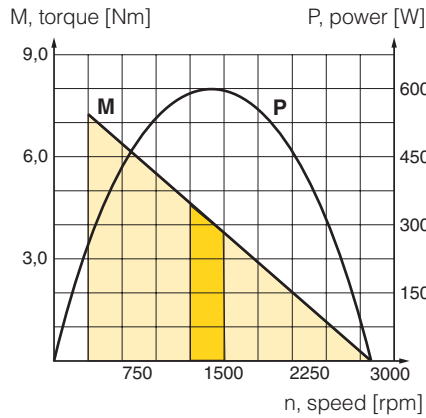

P1V-M060A0150

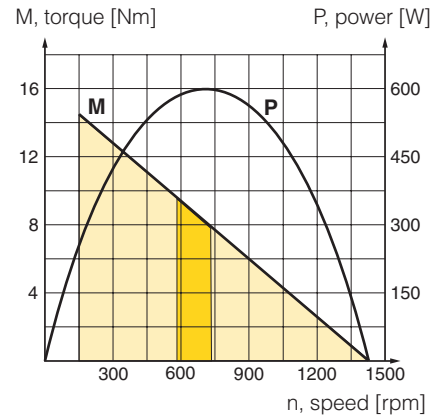

P1V-M060A0081

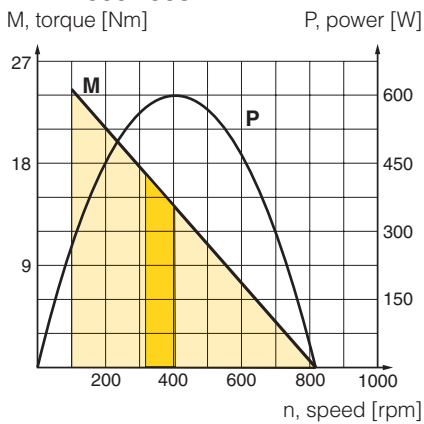

P1V-M060A0041

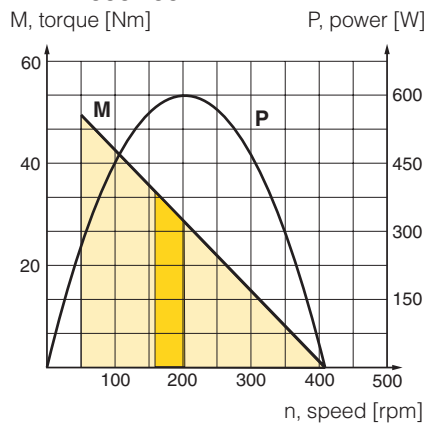

P1V-M060A0021

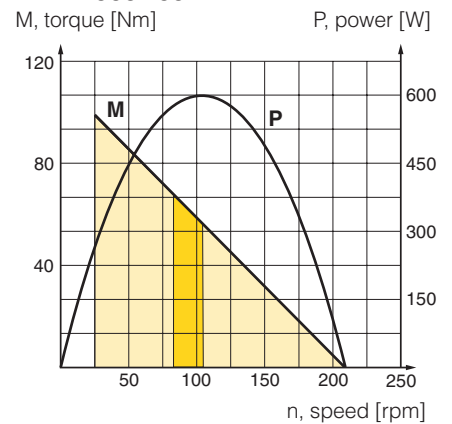

P1V-M060A0009

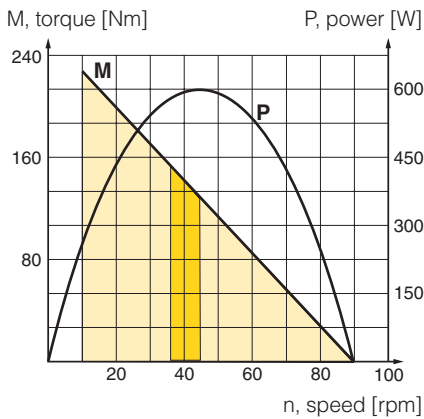

P1V-M060A0006

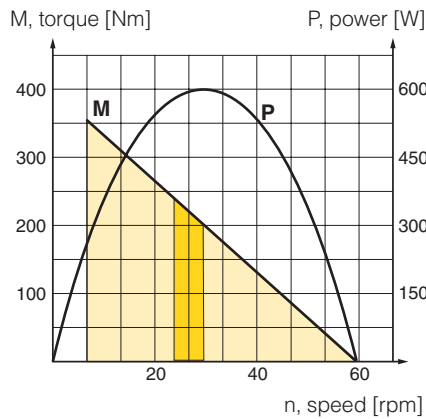

P1V-M060A0003

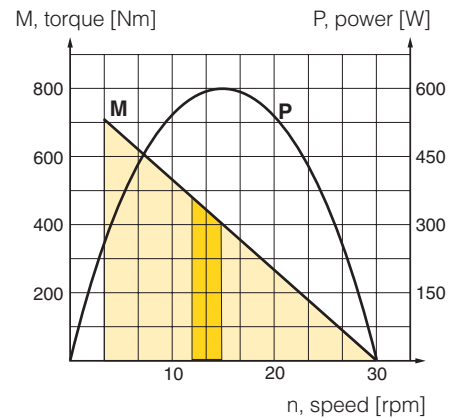

 Possible working range of motor.

 Optimum working range of motor.

Higher speeds = more vane wear
Lower speeds with high torque = more gearbox wear

Dimensions

Motor P1V-M0●0A0A00

Motor P1V-M0●0A0290

Motor P1V-M0●0A0150

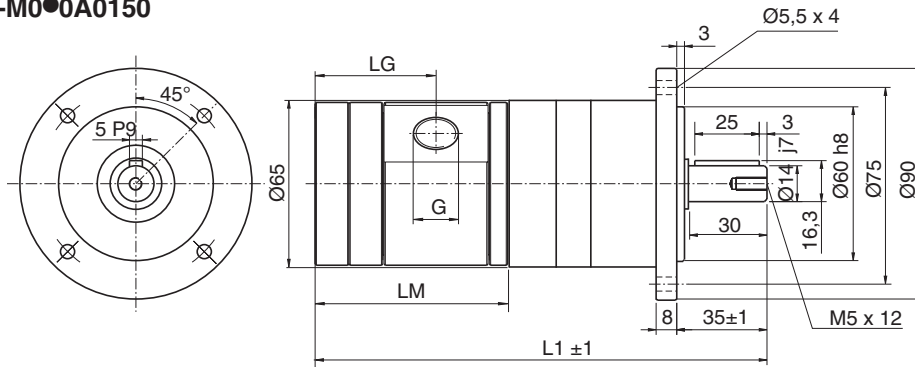

Motor P1V-M0●0A0081

Motor P1V-M0●0A0041

Motor P1V-M0●0A0021

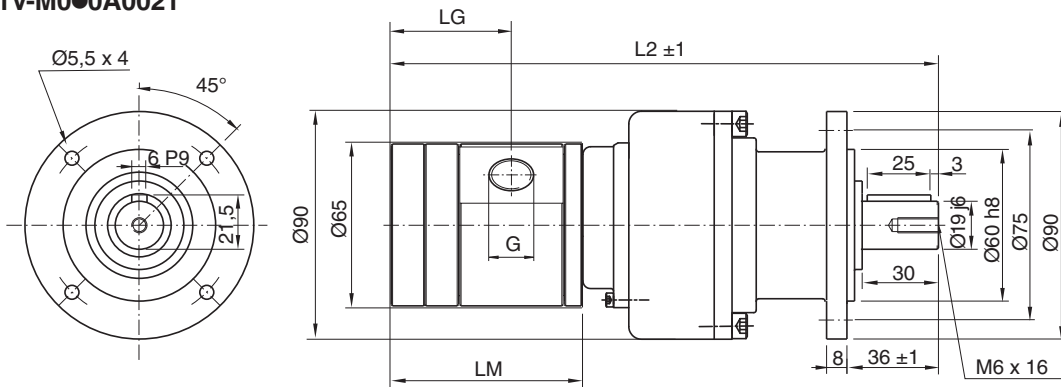

Motor P1V-M0●0A0009

Motor P1V-M0●0A0006

Motor P1V-M0●0A0003

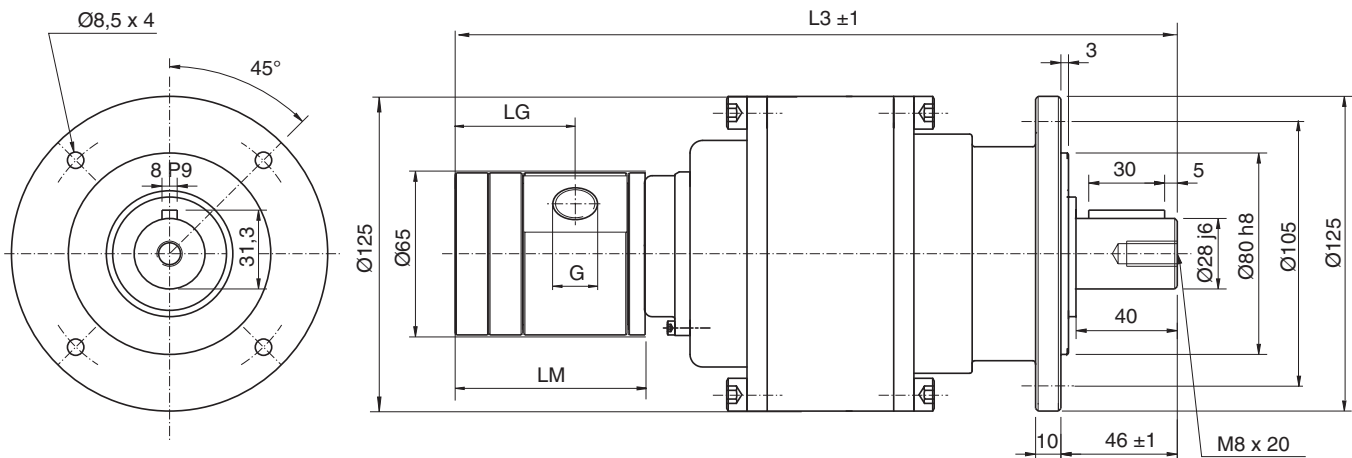

Motor type	G	LG	LM	L1	L2	L3
P1V-M020A	G1/8	39,0	57,5	160,5	197,5	267,5
P1V-M040A	G3/8	49,0	77,5	180,5	217,5	287,5
P1V-M060A	G3/8	56,5	92,0	195,0	232,0	302,0

Foot brackets for P1V-M

Type	For air motor	Weight	Order code Kg
Foot bracket	P1V-M0•0A0A00	0,63	P1V-MF1
	P1V-M0•0A0290		
	P1V-M0•0A0150		
	P1V-M0•0A0081		
	P1V-M0•0A0041		
	P1V-M0•0A0021		
	P1V-M0•0A0009	1,70	P1V-MF2
	P1V-M0•0A0006		
	P1V-M0•0A0003		



All brackets supplied with fastening screws for the motor.

Dimensions

P1V-MF1

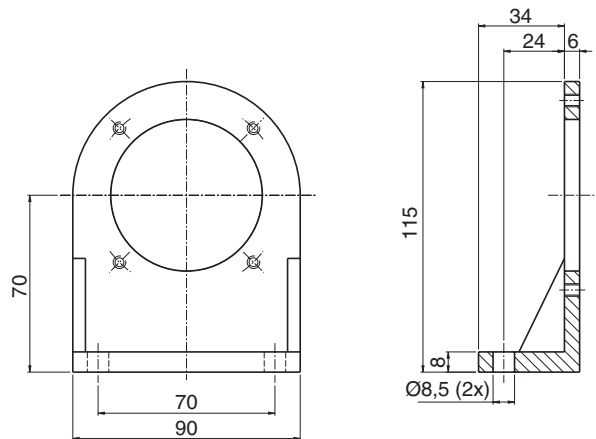

P1V-MF2

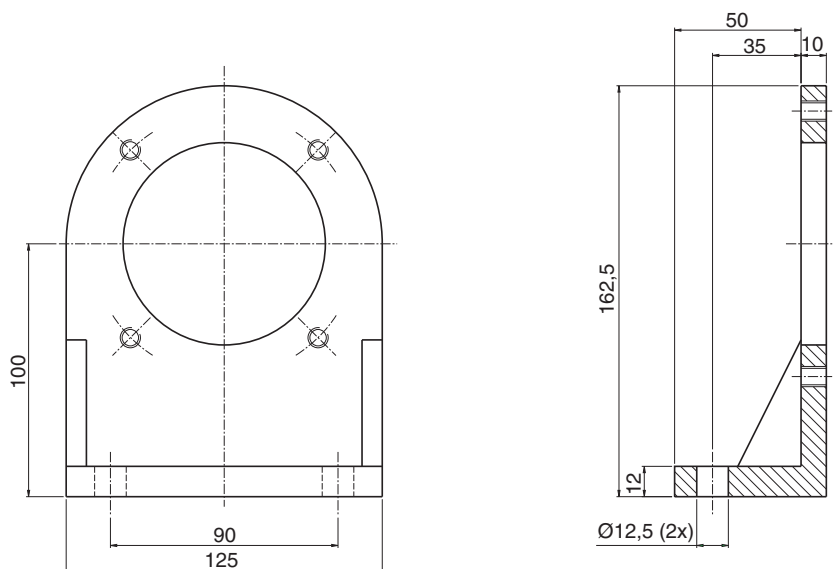

Theoretical calculations

This section provides you with the background you need in order to select the right air motor for common applications. The first four parts explain the direct physical relationships between:

Force - Torque - Speed - Power Requirement

Before selecting an air motor, you need to know the torque required by the application at the necessary speed. Sometimes, the torque and the speed are not known but the power requirement and the speed of movement are. You can use the following formulas to calculate the speed and torque.

Power

The power requirement is always calculated in N.

Formula:

$$F = m \times g$$

F = power in N

m = mass in kg

g = gravitation (9,81) in m/s²

In this example, the mass is 150 kg

$$F = 150 \times 9,81 \text{ N}$$

$$F = 1470 \text{ N}$$

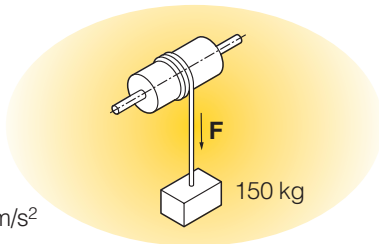

Torque

Torque is the force applied to produce rotational motion (rotational force) or the force applied in the opposite direction. It is the product of the rotational force F and the distance from the pivot point (radius or moment arm)

Formula:

$$M = m \times g \times r$$

M = torque in Nm

m = mass in kg

g = gravitation (9,81) in m/s²

r = radius or moment arm in m

In this example, the drum diameter is 300 mm, which means the radius r = 0,15 m, and the mass is 150kg.

$$M = 150 \times 9,81 \times 0,15 \text{ Nm}$$

$$M = 221 \text{ Nm}$$

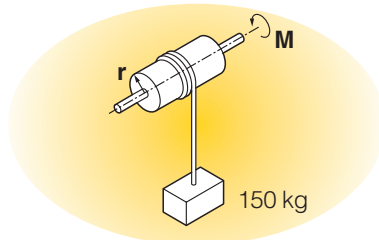

Speed

The required motor speed can be calculated if the speed of movement and the radius (diameter) are known.

$$n = v \times 60 / (2 \times \pi \times r)$$

n = motor speed in rpm

v = speed of movement in m/sec

r = radius in m

π = constant (3,14)

In this example, the speed of movement is 1,5 m/s and the drum diameter is 300 m (radius r = 0,15 m)

$$n = 1,5 \times 60 / (2 \times \pi \times 0,15) \text{ rpm}$$

$$n = 96 \text{ rpm}$$

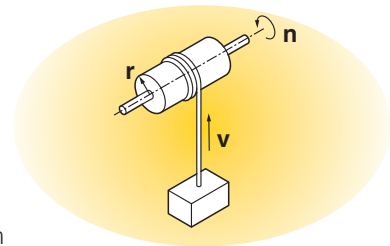

Power Requirement

The power requirement can be calculated if the motor speed and torque are known.

$$P = M \times n / 9550$$

P = power in kW

M = torque in Nm

n = rpm

9550 = conversion factor

In this example, a torque of 1,25 Nm is required at a speed of 1500 rpm.

$$P = 1,25 \times 1500 / 9550$$

$$P = 0,196 \text{ kW or approx. } 200 \text{ Watt}$$

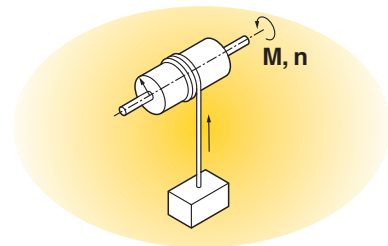

Frictional Forces between two Objects

A frictional force always occurs between two objects with surfaces in contact with each other. It is always exerted against the direction of movement.

The frictional force is either static or kinetic. When selecting an air motor, we need to consider the larger of the two forces, static or kinetic.

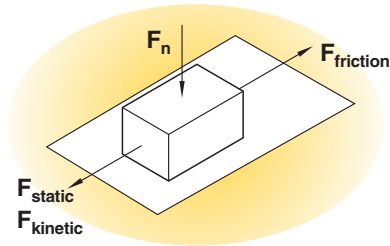

The size of the static frictional force or the kinetic frictional force is the product of the normal force F_n and the coefficient of static friction (μ_0), or the product of the normal force F_n and the coefficient of kinetic friction (μ).

The size of the contact surface between the objects is irrelevant.

Formula:

$$F_{\text{static}} = F_n \times \mu_0$$

$$F_{\text{kinetic}} = F_n \times \mu$$

$$F_n = m \times g$$

F_{static} = static friction in N

F_{kinetic} = kinetic friction in N

F_n = force from object in N

m = mass in kg

g = gravitation (9,81) in m/s²

Material		Coefficient of static friction μ_0	
		Dry	Lubricated
Bronze	Bronze	0,28	0,11
Bronze	Grey iron	0,28	0,16
Grey iron	Grey iron	-	0,16
Steel	Bronze	0,27	0,11
Steel	Ice	0,027	-
Steel	Grey iron	0,20	0,10
Steel	Steel	0,15	0,10
Steel	White metal	-	-
Wood	Ice	-	-
Wood	Wood	0,65	0,16
Leather	Grey iron	0,55	0,22
Brake lining	Steel	-	-
Steel	Nylon (polyamide)	-	-

Material		Coefficient of kinetic friction μ	
		Dry	Lubricated
Bronze	Bronze	0,2	0,06
Bronze	Grey iron	0,21	0,08
Grey iron	Grey iron	-	0,12
Steel	Bronze	0,18	0,07
Steel	Ice	0,014	-
Steel	Grey iron	0,16	0,05
Steel	Steel	0,10	0,05
Steel	White metal	0,20	0,04
Wood	Ice	0,035	-
Wood	Wood	0,35	0,05
Leather	Grey iron	0,28	0,12
Brake lining	Steel	0,55	0,40
Steel	Nylon (polyamide)	0,5	0,10

Example: A steel component with a weight of 500 kg is to be pulled across bronze plate without lubrication. What will the frictional force be when the component moves?

$$F_{\text{static}} = F_n \times \mu_0$$

$$F_{\text{kinetic}} = F_n \times \mu$$

$$F_{\text{static}} = 500 \times 9,81 \times 0,27 = 1324 \text{ N}$$

$$F_{\text{kinetic}} = 500 \times 9,81 \times 0,18 = 883 \text{ N}$$

The static frictional force should always be compared with the force provided by the motor when it starts.

Kinetic Resistance

Kinetic resistance is a term expressing the total resistance, consisting of rolling resistance and the frictional force in the bearing

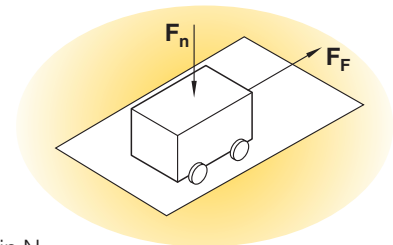

Formula:

$$F_F = \mu_F \times F_n$$

F_F = kinetic resistance in N

μ_F = coefficient of kinetic resistance

F_n = force from object in N

Coefficient of kinetic resistance:

Object	Coefficient of kinetic resistance
Railway vehicle on steel rails	0,0015 to 0,0030
Vehicle with rubber wheel on asphalt	0,015 to 0,03

Example:

A railway carriage with a weight of 2 tonnes is to move over flat rails. What will the kinetic resistance be?

$$F_F = \mu_F \times F_n$$

$$F_F = 0,0030 \times 2 \times 1000 \times 9,81$$

$$F_F = 4,86 \text{ N}$$

Moving a component over a base, with friction between them

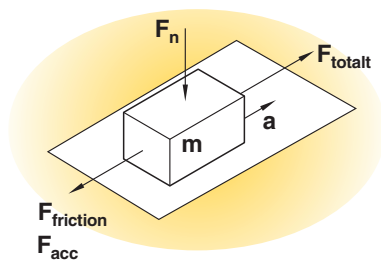

The force required to move the component consists of two parts - a frictional force to move the component over the base, and an acceleration force

$$F_{\text{tot}} = F_{\text{friction}} + F_{\text{acc}}$$

$$F_{\text{acc}} = m \times a$$

$$F_{\text{tot}} = F_{\text{friction}} + m \times a$$

F_{tot} = the total force required in order to move the object in N

F_{friction} = frictional force in N (either F_{static} or F_{kinetic} depending on which is the greater force)

F_{acc} = acceleration force in N

m = mass in kg

a = acceleration in m/s^2

A steel component weighing 500 kg is to be pulled over a dry steel plate with an acceleration of $0,1 \text{ m/s}^2$. What is the total force required to produce this movement?

$$F_{\text{tot}} = F_{\text{kinetic}} + F_{\text{acc}}$$

$$F_{\text{tot}} = F_{\text{kinetic}} + m \times a$$

$$F_{\text{tot}} = F_n \times u + m \times a$$

$$F_{\text{tot}} = 500 \times 9,81 \times 0,15 + 500 \times 0,1$$

$$F_{\text{tot}} = 735,75 + 50$$

$$F_{\text{tot}} = 785,75 \text{ N}$$

Answer: A force of 780 N is required to produce this movement.

Moving a carriage over rails, with kinetic resistance between them

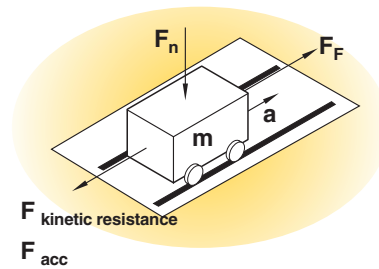

The force required to move the component consists of two parts - a kinetic resistance to move the component over the base, and an acceleration force

$$F_{\text{tot}} = F_{\text{kinetic resistance}} + F_{\text{acc}}$$

$$F_{\text{acc}} = m \times a$$

$$F_{\text{tot}} = F_{\text{kinetic resistance}} + m \times a$$

F_{tot} = the total force required in order to move the object in N

$F_{\text{kinetic resistance}}$ = total kinetic resistance in N

F_{acc} = acceleration force in N

m = mass in kg

a = acceleration in m/s^2

A carriage weighing 2500 kg is to be pulled over steel rails with an acceleration of $0,2 \text{ m/s}^2$. What is the total force required to produce this movement?

$$F_{\text{tot}} = F_{\text{kinetic resistance}} + F_{\text{acc}}$$

$$F_{\text{tot}} = u_F \times F_N + m \times a$$

$$F_{\text{tot}} = 0,0030 \times 2500 \times 9,81 + 2500 \times 0,2$$

$$F_{\text{tot}} = 6,1 + 500$$

$$F_{\text{tot}} = 506 \text{ N}$$

Answer: A force of 510 N is required to produce this movement.

In practice

These calculations only produce values as they would be under optimum conditions. There must be no inclines in either direction. In applications using carriages, the rails must be perfectly flat without any inclines, the wheels must be perfectly round and there must be nothing on the rails (grains of sand, etc.). There must also be no effects from wind, etc.

In addition, there is always uncertainty with regard to the compressed air supply. How can we guarantee a pressure of 6 bar to the inlet port of the air motor?

Tip: calculate the required theoretical values for the air motor and assume a safety factor of 10 for the frictional force or kinetic resistance, and add this to the acceleration force. If the motor proves to be too powerful in practice, the supply air can always be regulated by throttling or pressure regulation. If you select a motor that is not powerful enough, on the other hand, the only option is to replace it.

P1V-M Service – Easier - Faster - Cheaper

Replacing vanes - step by step.

Step 1.

Remove the rear piece.



Step 2.

Remove the inspection plug.



Step 3.

Use a screwdriver to rotate the motor until you can see a vane in the centre of the inspection hole.



Step 4.

Remove the old vane and replace it with a new one.



Repeat steps 3 and 4 until all the vanes have been replaced.

Step 5.

Replace the inspection plug.



Step 6.

Replace the rear piece.



Replacing vanes with motor still fitted to the machine

The P1V-M motor has been developed to allow the vanes to be replaced without the need to remove the motor from the machine. This makes vane replacement easier, quicker and cheaper, while minimising stoppages.

Service intervals are described on page 10.

Torque, power and air consumption graphs

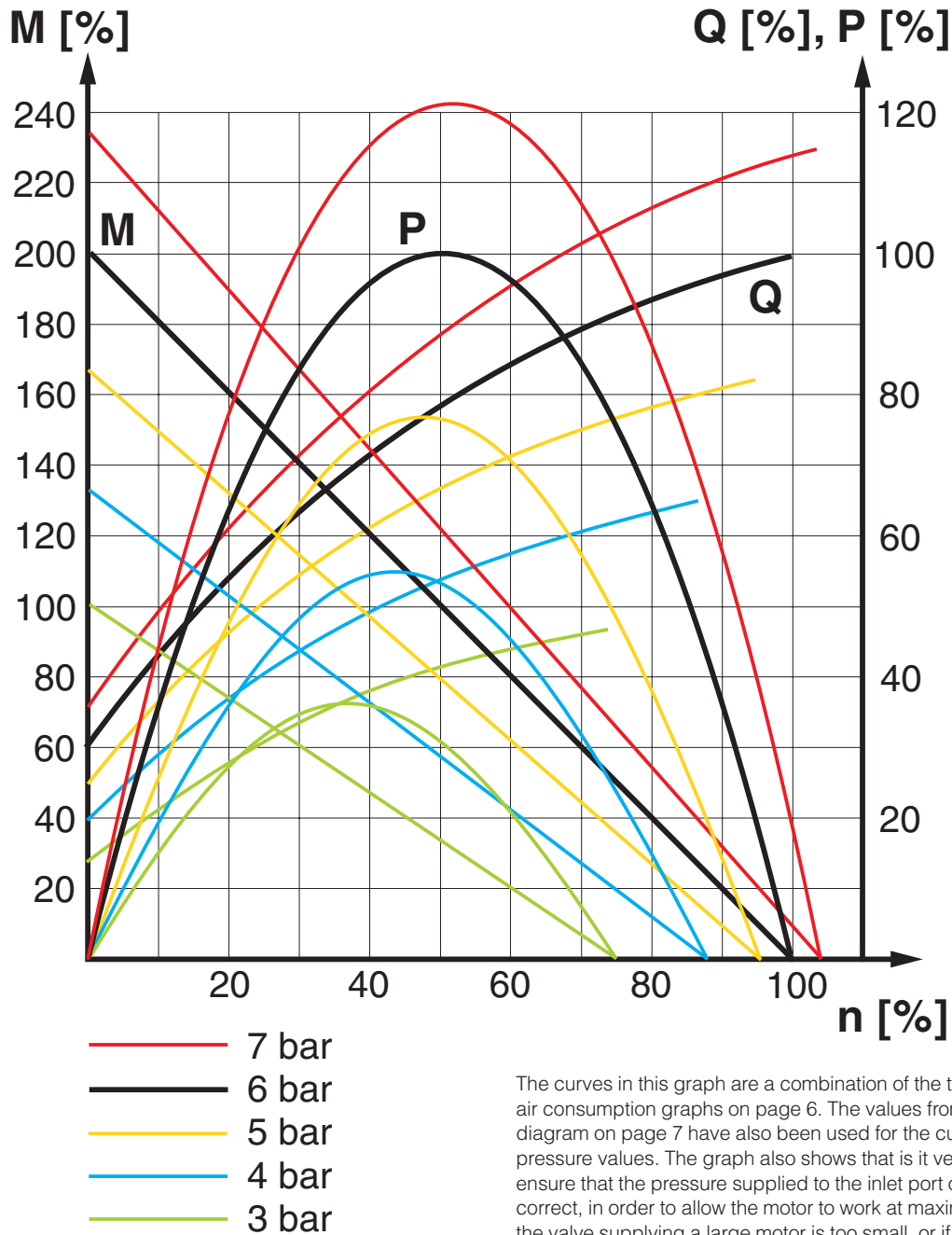

P = power **Q = air consumption**
M = torque **n = speed**

The curves in this graph are a combination of the torque, power and air consumption graphs on page 6. The values from the correction diagram on page 7 have also been used for the curves for the different pressure values. The graph also shows that it is very important to ensure that the pressure supplied to the inlet port of the motor is correct, in order to allow the motor to work at maximum capacity. If the valve supplying a large motor is too small, or if the supply line is underspecified, the pressure at the inlet port may be so low that the motor is unable to do its work. One solution would be to upgrade the valve and supply system, or alternatively you could replace the motor with a smaller motor with lower air consumption. The result would be increased pressure at the inlet port, which means that the smaller motor could carry out the necessary work. However, you may need to select a smaller motor with a lower free speed in order to obtain sufficient torque at the outgoing shaft.

Sales Offices

AE – United Arab Emirates,
Abu Dhabi
Tel: +971 2 67 88 587
parker.me@parker.com

AR – Argentina, Buenos Aires
Tel: +54 3327 44 4129

AT – Austria, Wiener Neustadt
Tel: +43 (0)2622 23501-0
parker.austria@parker.com

AT – Austria, Wiener Neustadt
(Eastern Europe)
Tel: +43 (0)2622 23501 970
parker.easteurope@parker.com

AU – Australia, Castle Hill
Tel: +61 (0)2-9634 7777

AZ – Azerbaijan, Baku
Tel: +994 50 2233 458
parker.azerbaijan@parker.com

BE – Belgium, Nivelles
Tel: +32 (0)67 280 900
parker.belgium@parker.com

BR – Brazil, Cachoeirinha RS
Tel: +55 51 3470 9144

BY – Belarus, Minsk
Tel: +375 17 209 9399
parker.belarus@parker.com

CA – Canada, Milton, Ontario
Tel: +1 905 693 3000

CH – Switzerland
Tel: +41 31 917 18 51
parker.switzerland@parker.com

CN – China, Shanghai
Tel: +86 21 5031 2525

CN – China, Beijing
Tel: +86 10 6561 0520

CZ – Czech Republic, Klecany
Tel: +420 284 083 111
parker.czechrepublic@parker.com

DE – Germany, Kaarst
Tel: +49 (0)2131 4016 0
parker.germany@parker.com

DK – Denmark, Ballerup
Tel: +45 43 56 04 00
parker.denmark@parker.com

ES – Spain, Madrid
Tel: +34 902 33 00 01
parker.spain@parker.com

FI – Finland, Vantaa
Tel: +358 (0)20 753 2500
parker.finland@parker.com

FR – France,
Contamine-sur-Arve
Tel: +33 (0)4 50 25 80 25
parker.france@parker.com

GR – Greece, Athens
Tel: +30 210 933 6450
parker.greece@parker.com

HK – Hong Kong
Tel: +852 2428 8008

HU – Hungary, Budapest
Tel: +36 1 220 4155
parker.hungary@parker.com

IE – Ireland, Dublin
Tel: +353 (0)1 466 6370
parker.ireland@parker.com

IN – India, Mumbai
Tel: +91 22 6513 7081-85

IT – Italy, Corsico (MI)
Tel: +39 02 45 19 21
parker.italy@parker.com

JP – Japan, Fujisawa
Tel: +(81) 4 6635 3050

KR – South Korea, Seoul
Tel: +82 2 559 0400

KZ – Kazakhstan, Almaty
Tel: +7 3272 505 800
parker.easteurope@parker.com

LV – Latvia, Riga
Tel: +371 74 52601
parker.latvia@parker.com

MX – Mexico, Apodaca
Tel: +52 81 8156 6000

MY – Malaysia, Subang Jaya
Tel: +60 3 5638 1476

NL – The Netherlands,
Oldenzaal
Tel: +31 (0)541 585 000
parker.nl@parker.com

NO – Norway, Ski
Tel: +47 64 91 10 00
parker.norway@parker.com

NZ – New Zealand, Mt Wellington
Tel: +64 9 574 1744

PL – Poland, Warsaw
Tel: +48 (0)22 573 24 00
parker.poland@parker.com

PT – Portugal, Leca da Palmeira
Tel: +351 22 999 7360
parker.portugal@parker.com

RO – Romania, Bucharest
Tel: +40 21 252 1382
parker.romania@parker.com

RU – Russia, Moscow
Tel: +7 495 645-2156
parker.russia@parker.com

SE – Sweden, Spånga
Tel: +46 (0)8 59 79 50 00
parker.sweden@parker.com

SG – Singapore
Tel: +65 6887 6300

SL – Slovenia, Novo Mesto
Tel: +386 7 337 6650
parker.slovenia@parker.com

SK – Slovakia
Tel: +421 484 162 252
parker.slovakia@parker.com

TH – Thailand, Bangkok
Tel: +662 717 8140

TR – Turkey, Merter/Istanbul
Tel: +90 212 482 91 06 or 07
parker.turkey@parker.com

TW – Taiwan, Taipei
Tel: +886 2 2298 8987

UA – Ukraine, Kyiv
Tel: +380 44 494 2731
parker.ukraine@parker.com

UK – United Kingdom, Warwick
Tel: +44 (0)1926 317 878
parker.uk@parker.com

US – USA, Cleveland
Tel: +1 216 896 3000

US – USA, Miami
(Pan American Division)
Tel: +1 305 470 8800

VE – Venezuela, Caracas
Tel: +58 212 238 5422

ZA – South Africa, Kempton Park
Tel: +27 (0)11 961 0700
parker.southafrica@parker.com

